

Cree® XLamp® XP-G LEDs

Data Sheet

The XLamp XP-G LED delivers unprecedented levels of light output and efficacy for a single die LED. The XLamp XP-G LED continues Cree’s history of innovation in LEDs for lighting applications with wide viewing angle, symmetrical package, unlimited floor life and electrically neutral thermal path.

XLamp XP-G LEDs are the ideal choice for lighting applications where high light output and maximum efficacy are required, such as LED light bulbs, outdoor lighting, portable lighting, indoor lighting and solar-powered lighting.

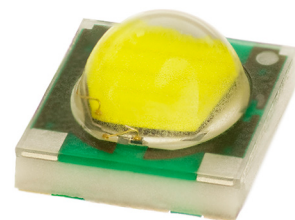

FEATURES

- Available in white and outdoor white
- ANSI-compatible chromaticity bins
- Maximum drive current: 1500 mA
- Low thermal resistance: 6°C/W
- Wide viewing angle: 125°
- Unlimited floor life at $\leq 30^{\circ}\text{C}/85\% \text{ RH}$
- Reflow solderable - JEDEC J-STD-020C
- Electrically neutral thermal path
- RoHS and REACH-compliant
- UL-recognized component (E326295)

Table of Contents

Flux Characteristics ($T_j = 25^{\circ}\text{C}$).....	2
Characteristics	2
Relative Spectral Power Distribution	3
Relative Flux vs. Junction Temperature ($I_f = 350 \text{ mA}$).....	3
Electrical Characteristics ($T_j = 25^{\circ}\text{C}$)	4
Thermal Design	4
Relative Flux vs. Current ($T_j = 25^{\circ}\text{C}$)	5
Typical Spatial Distribution	5
Reflow Soldering Characteristics	6
Notes.....	7
Mechanical Dimensions ($T_A = 25^{\circ}\text{C}$)	8
Tape and Reel	9
Packaging.....	10



Flux Characteristics (T_j = 25°C)

The following table provides several base order codes for XLamp XP-G LEDs. It is important to note that the base order codes listed here are a subset of the total available order codes for the product family.

Color	CCT Range		Base Order Codes Min Luminous Flux @ 350 mA (lm)		Order Code
	Min.	Max.	Group	Flux (lm)	
Cool White	5,000 K	8,300 K	R2	114	XPGWHT-L1-0000-00E51
			R3	122	XPGWHT-L1-0000-00F51
			R4	130	XPGWHT-L1-0000-00G51
			R5	139	XPGWHT-L1-0000-00H51
Outdoor White	4,000 K	5,300 K	R2	114	XPGWHT-01-0000-00EC2
			R3	122	XPGWHT-01-0000-00FC2
			R4	130	XPGWHT-01-0000-00GC2
Neutral White	3,700 K	5,000 K	Q5	107	XPGWHT-L1-0000-00DE4
			R2	114	XPGWHT-L1-0000-00EE4
			R3	122	XPGWHT-L1-0000-00FE4
Warm White	2,600 K	3,700 K	Q3	93.9	XPGWHT-L1-0000-00BE7
			Q4	100	XPGWHT-L1-0000-00CE7
			Q5	107	XPGWHT-L1-0000-00DE7

Notes:

- Cree maintains a tolerance of +/- 7% on flux and power measurements.
- Typical CRI for Cool White and Neutral White (3,700 K - 10,000 K CCT) is 75.
- Typical CRI for Outdoor White (4,000 K - 5,300 K CCT) is 70.
- Typical CRI for Warm White (2,600 K - 3,700 K CCT) is 80.

Characteristics

Characteristics	Unit	Minimum	Typical	Maximum
Thermal resistance, junction to solder point	°C/W		6	
Viewing angle (FWHM)	degrees		125	
Temperature coefficient of voltage	mV/°C		-2.1	
ESD classification (HBM per Mil-Std-883D)			Class 2	
DC forward current	mA			1500
Reverse voltage	V			5
Forward voltage (@ 350 mA)	V		3.0	3.75
Forward voltage (@ 700 mA)	V		3.2	
Forward voltage (@ 1000 mA)	V		3.3	
LED junction temperature	°C			150

* The increase of maximum forward current to 1500 mA for XLamp XP-G Cool White is retroactive and applies to all XLamp XP-G Cool White LEDs produced by Cree. The increase is the result of more extensive qualification testing that was performed after the initial product launch.

Relative Spectral Power Distribution

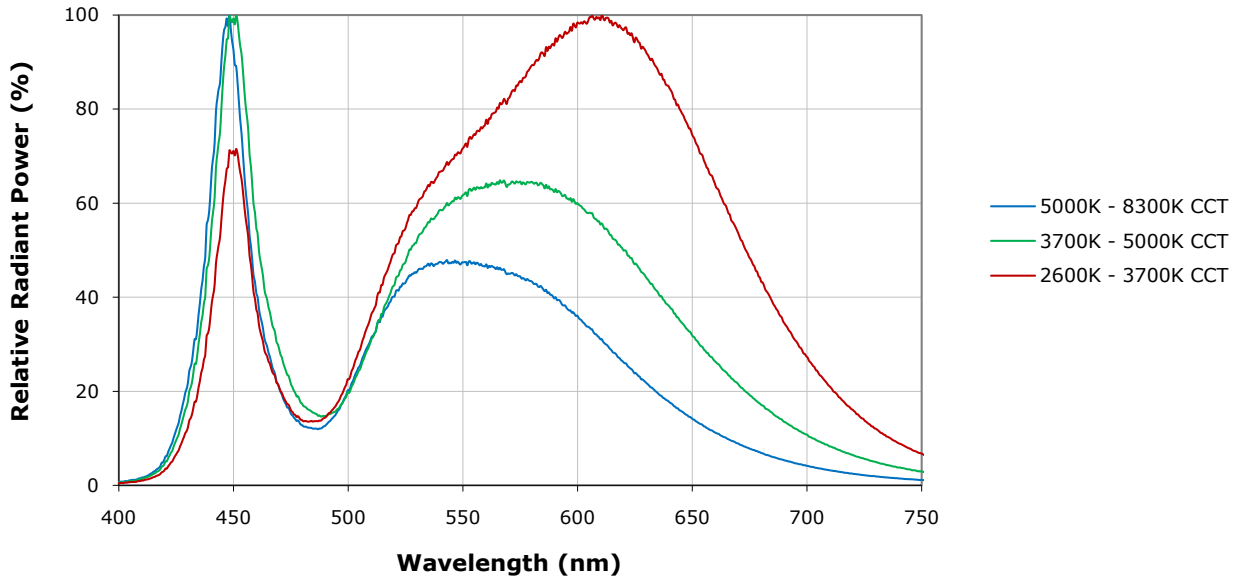

Relative Flux vs. Junction Temperature ($I_f = 350$ mA)

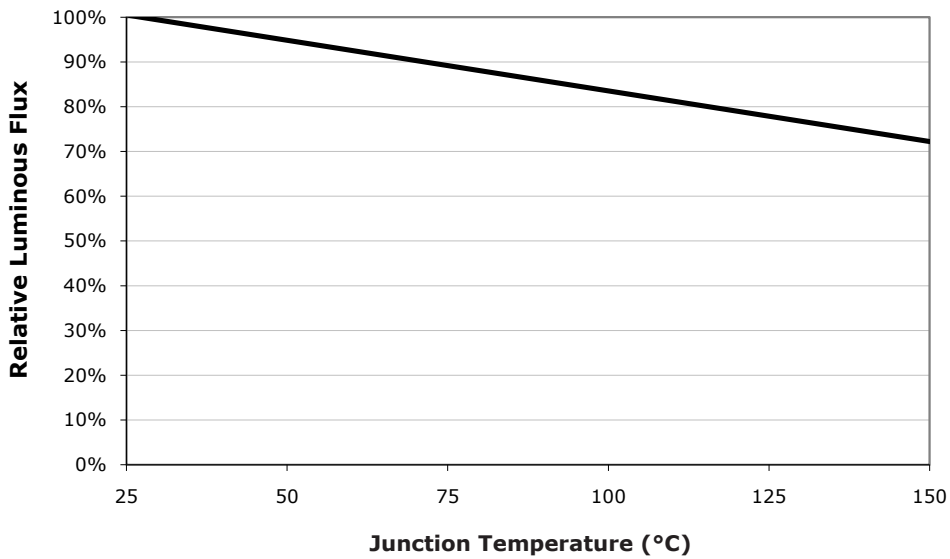

Electrical Characteristics ($T_j = 25^\circ\text{C}$)

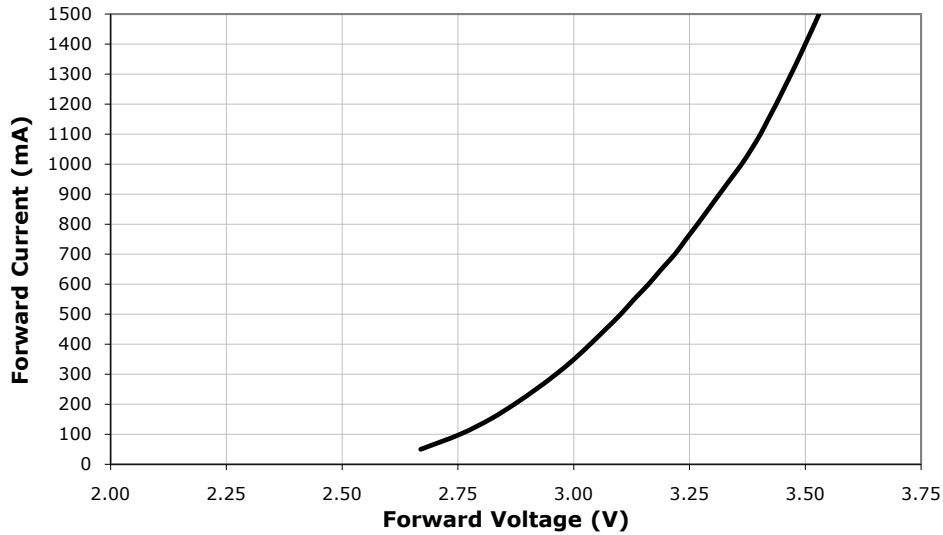

Thermal Design

The maximum forward current is determined by the thermal resistance between the LED junction and ambient. It is crucial for the end product to be designed in a manner that minimizes the thermal resistance from the solder point to ambient in order to optimize lamp life and optical characteristics.

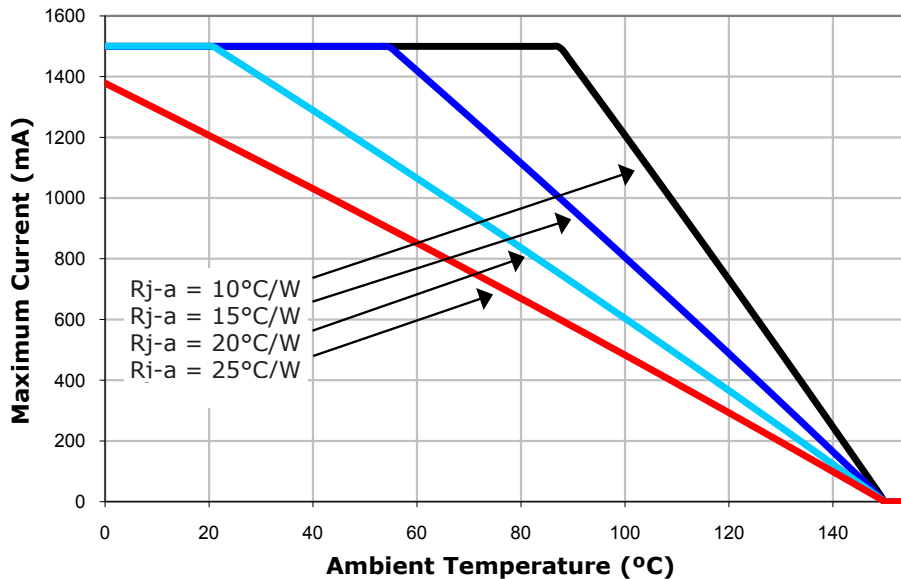



Relative Flux vs. Current ($T_1 = 25^\circ\text{C}$)

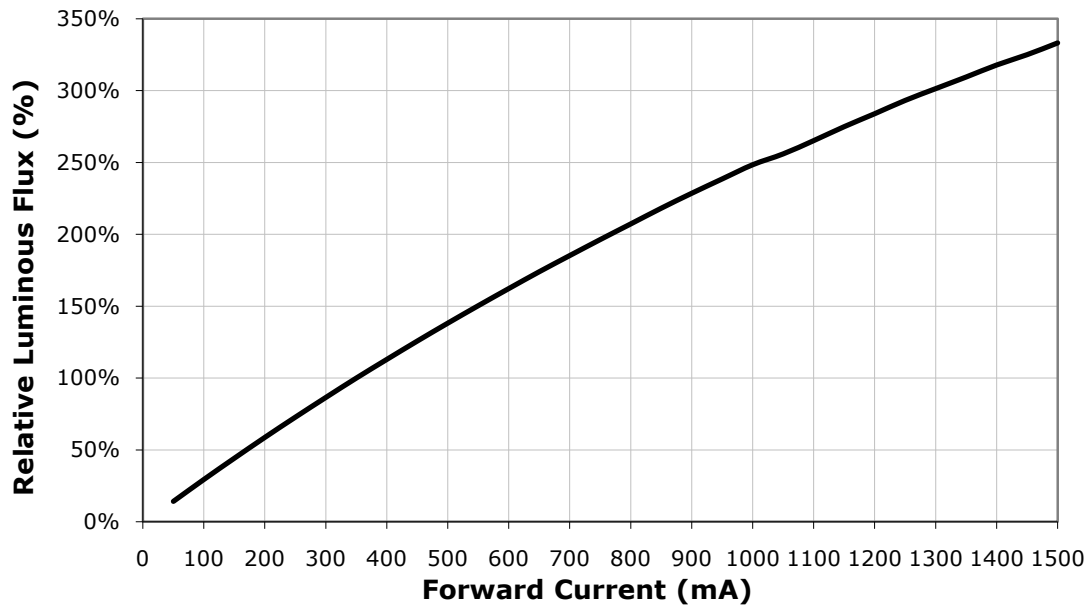

Typical Spatial Distribution

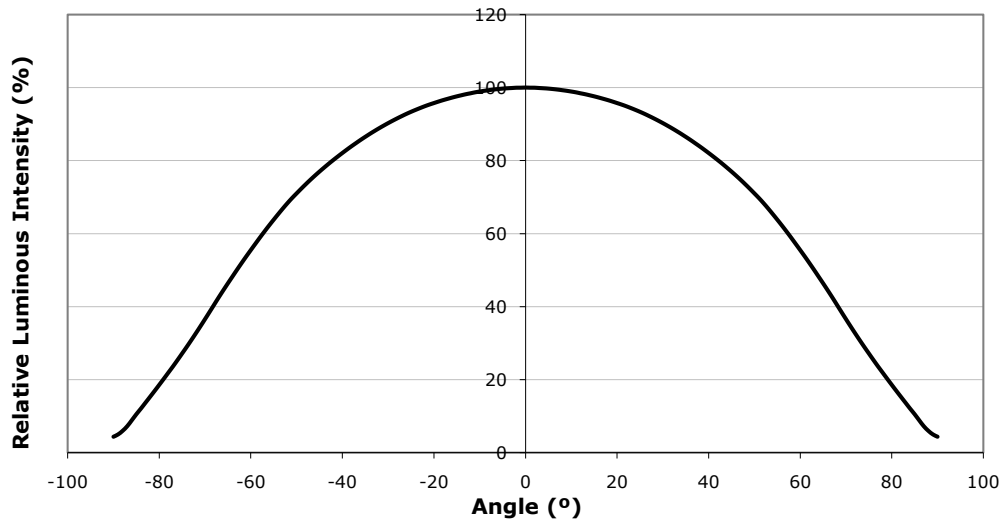

Reflow Soldering Characteristics

In testing, Cree has found XLamp XP-G LEDs to be compatible with JEDEC J-STD-020C, using the parameters listed below. As a general guideline, Cree recommends that users follow the recommended soldering profile provided by the manufacturer of solder paste used.

Note that this general guideline may not apply to all PCB designs and configurations of reflow soldering equipment.

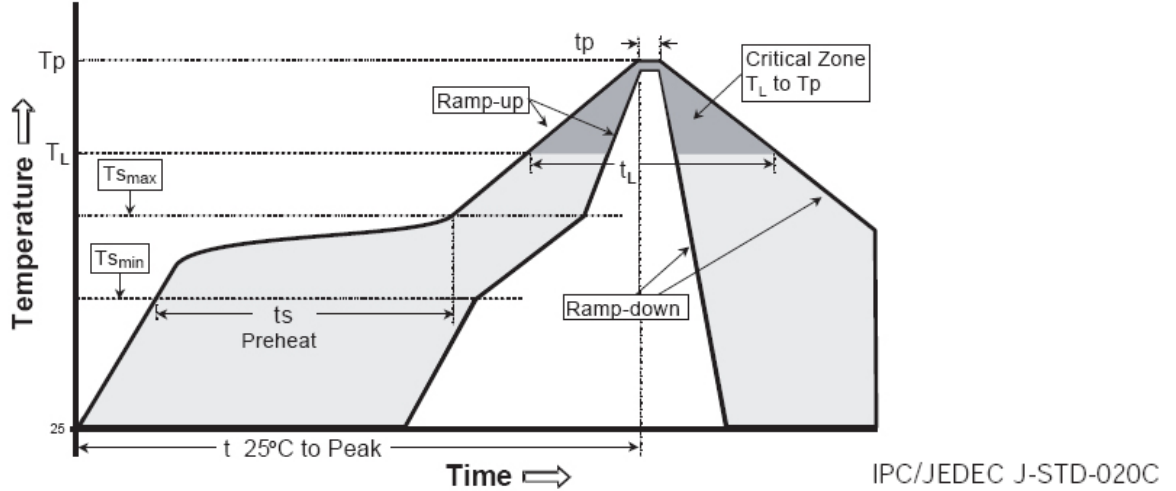

Profile Feature	Lead-Based Solder	Lead-Free Solder
Average Ramp-Up Rate ($T_{s_{max}}$ to T_p)	3°C/second max.	3°C/second max.
Preheat: Temperature Min ($T_{s_{min}}$)	100°C	150°C
Preheat: Temperature Max ($T_{s_{max}}$)	150°C	200°C
Preheat: Time ($t_{s_{min}}$ to $t_{s_{max}}$)	60-120 seconds	60-180 seconds
Time Maintained Above: Temperature (T_l)	183°C	217°C
Time Maintained Above: Time (t_l)	60-150 seconds	60-150 seconds
Peak/Classification Temperature (T_p)	215°C	260°C
Time Within 5°C of Actual Peak Temperature (t_p)	10-30 seconds	20-40 seconds
Ramp-Down Rate	6°C/second max.	6°C/second max.
Time 25°C to Peak Temperature	6 minutes max.	8 minutes max.

Note: All temperatures refer to topside of the package, measured on the package body surface.



Notes

Lumen Maintenance Projections

Cree currently recommends a maximum drive current of 1000 mA for XLamp XP-G white in designs seeking the ENERGY STAR* 35,000 hour lifetime rating ($\geq 94.1\%$ luminous flux @ 6000 hours) or 25,000-hour lifetime rating ($\geq 91.8\%$ luminous flux @ 6000 hours).

Please read the XLamp Long-Term Lumen Maintenance application note for more details on Cree's lumen maintenance testing and forecasting. Please read the XLamp Thermal Management application note for details on how thermal design, ambient temperature, and drive current affect the LED junction temperature.

* These lifetime ratings are based on the current ENERGY STAR Solid State Lighting Luminaires V1.1 (December 12, 2008) and ENERGY STAR Integral LED Lamps V1.0 (December 3, 2009) lumen maintenance criteria.

Moisture Sensitivity

In testing, Cree has found XLamp XP-G LEDs to have unlimited floor life in conditions $\leq 30^{\circ}\text{C}$ / 85% relative humidity (RH). Moisture testing included a 168 hour soak at 85°C / 85% RH followed by 3 reflow cycles, with visual and electrical inspections at each stage.

RoHS Compliance

The levels of environmentally sensitive, persistent biologically toxic (PBT), persistent organic pollutants (POP), or otherwise restricted materials in this product are below the maximum concentration values (also referred to as the threshold limits) permitted for such substances, or are used in an exempted application, in accordance with EU Directive 2002/95/EC on the restriction of the use of certain hazardous substances in electrical and electronic equipment (RoHS), as amended through April 21, 2006.

Vision Advisory Claim

Users should be cautioned not to stare at the light of this LED product. The bright light can damage the eye.

Mechanical Dimensions (T_A = 25°C)

All measurements are ±.13 mm unless otherwise indicated.

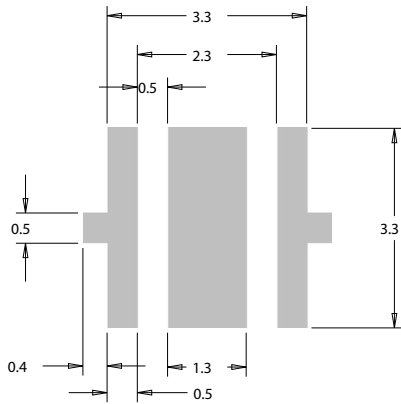
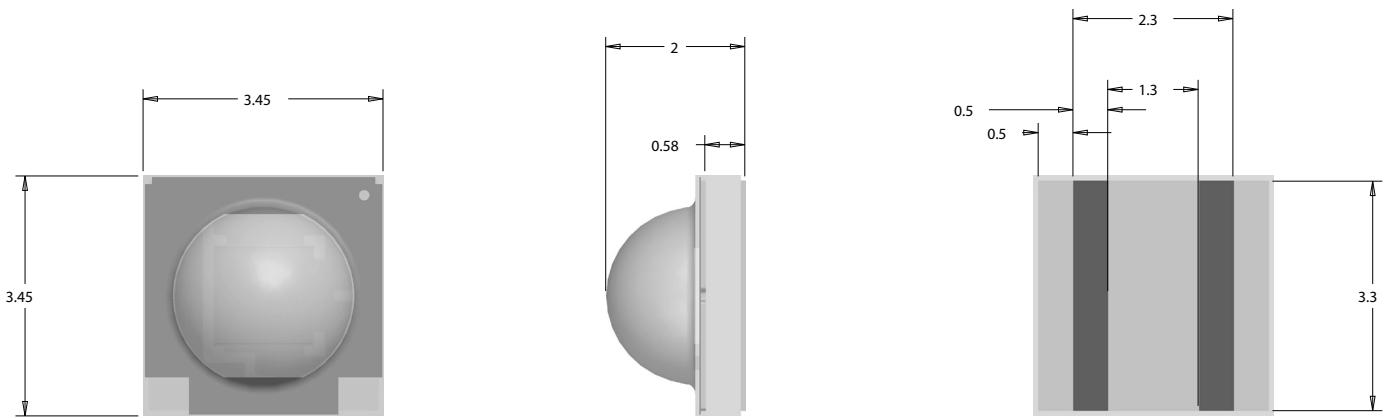
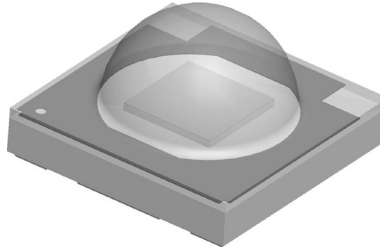

Recommended PCB Solder Pad

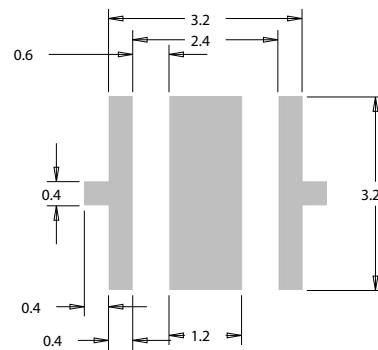

Recommended Stencil Pattern
(hatched area is opening)

Tape and Reel

All dimensions in mm.

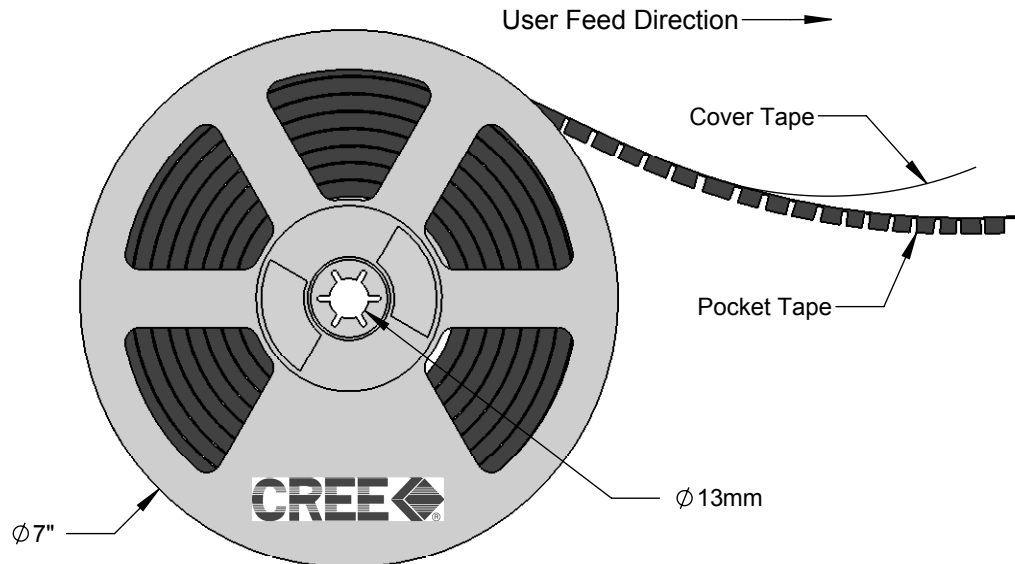
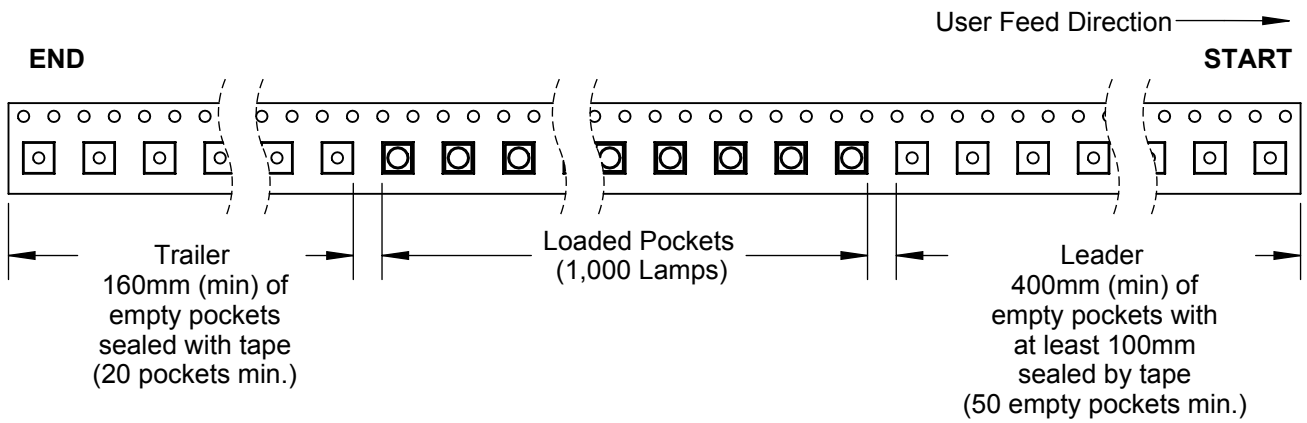
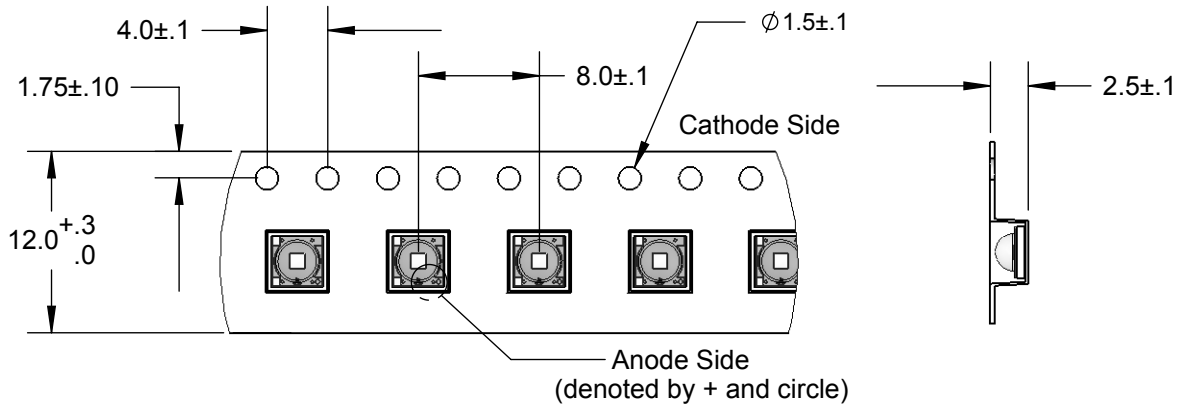

Packaging

All dimensions in mm.

